



THE EVOLUTION OF MODULAR UPS

Advanced *Power Conversion* Solutions



THE BRITISH POWER CONVERSION COMPANY™

WHO WE ARE

Founded in 1996, The British Power Conversion Company, based in Romsey, Hampshire, is an independently owned international corporation offering an established and effective range of power protection products and services to a broad spectrum of industries and sectors.

Over the past 25 years our business has evolved and we no longer just operate under the traditional fields of UPS Systems and Batteries. Our continued growth in manufacturing of Modular UPS, Static Emergency Lighting Systems, Long Runtime Inverters and Static Transfer Switches for critical applications has developed into a major part of our group. We are also actively developing PV (Solar) and associated products for Wind and Turbine Generators to address the major growth in the 'Renewable Energy' market.

POWERTOWER GREEN TOPOLOGY

BPC realises the increased reliance on Data Centre equipment with uninterrupted availability is such that uptime is now essential for the business operation. The PowerTower Green modular UPS system offers reduced running costs, increased availability and provides a high efficiency solution that delivers energy saving value.

Along with the possible hardware, data loss and financial implications of unexpected downtime, new technologies are driving changes in the way uninterruptible power supplies are designed to offer the best in availability, flexibility, reliability and total cost of ownership.

The BPC PowerTower Green modular UPS series covers both chassis based and rack independent designs, incorporating hot swappable power modules, to deliver the best combination of reliability, functionality and scalability at a competitive price. Designed specifically for data centres, computer systems and critical applications, this innovative and reliable power system commits to meet the market requirements.

ENVIRONMENTAL SUSTAINABILITY

Demand on Data Centres is soaring due to further cloud integration, higher 5G demand and an ever increasing number of users. Computer processing power already consumes a significant portion of the country's electricity.

Energy accounts for approximately 60% of a Data Centre's overall running expense, so there is a continuing focus on reducing energy consumption and emissions in order to decrease overall operational costs and meet environmental legislation.

BPC UPS modular architecture is a major step forward over transformer based designs, or even other transformerless systems due to the PowerTowerGreen models dissipating less heat and therefore reducing the requirement for expensive and energy intensive air conditioning.



- **Save on Energy costs**
- **Save on Maintenance costs**
- **Fast to Repair (MTTR)**
- **Improved Reliability**

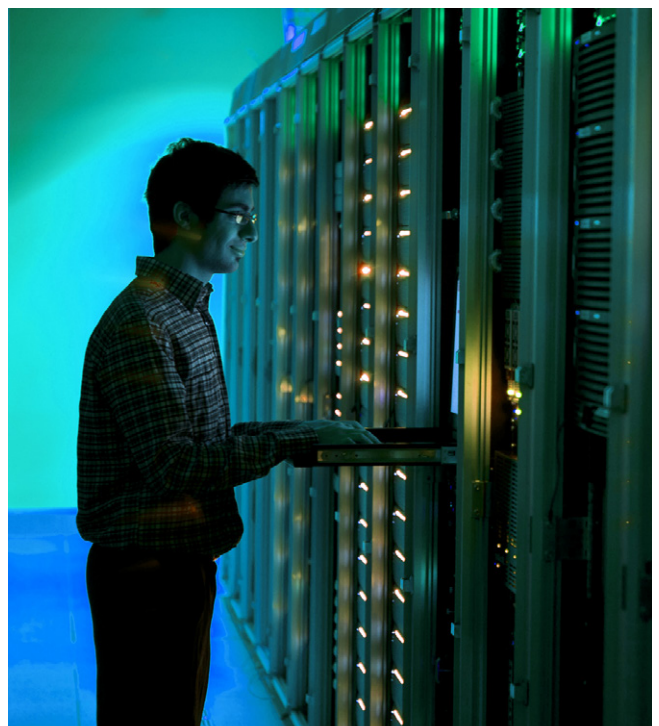

POWERTOWER GREEN MODULAR CONCEPT

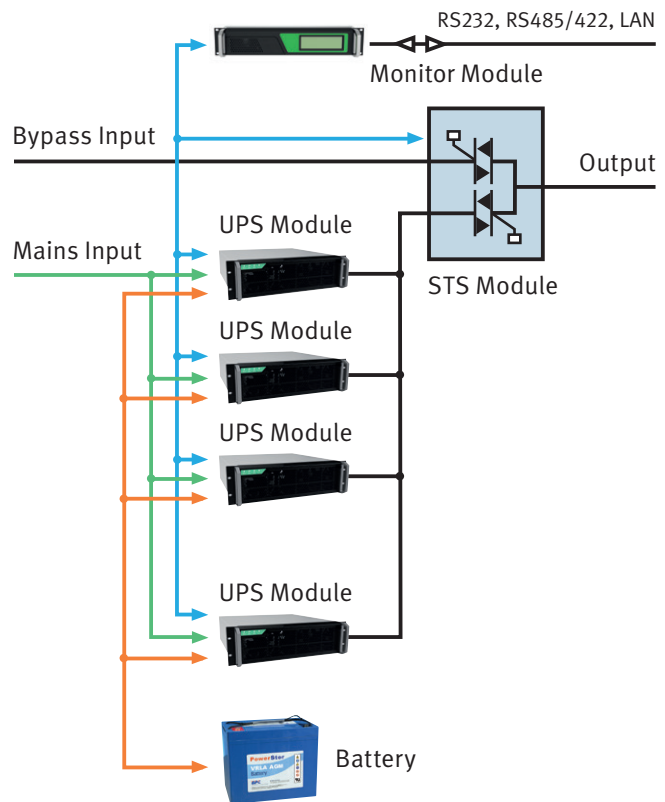

MODES OF ADVANCED OPERATION

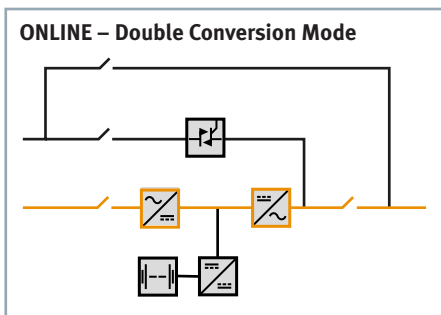

- UPS output PF=1, THDi $\leq 3\%$
- Efficiency more than 96.5%
- Mains battery seamless switching
- Meet the uninterrupted power supply and power quality of the load

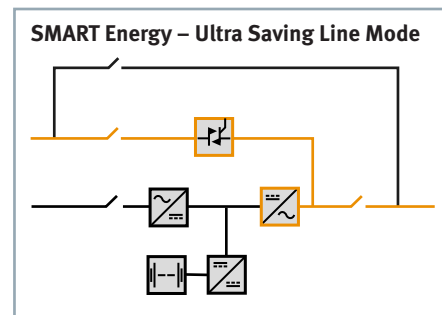

- Ultra high efficiency up to 98.8%
- Output quality regulation to load is of the highest standard available
- Mains power supply and battery power supply seamless switching
- Provide reactive power compensation and harmonic suppression to eliminate load interference back to the power grid
- Intelligent power test mode for testing UPS in the field without the need for renting load bank cabinet
- Battery and mains supply can be powered simultaneously to support high inrush and machinery start-up overloads
- In addition to the UPS function, this can be used as a Smart Storage device to avoid peak load electricity penalties during high tariff periods, thus saving considerable operating costs

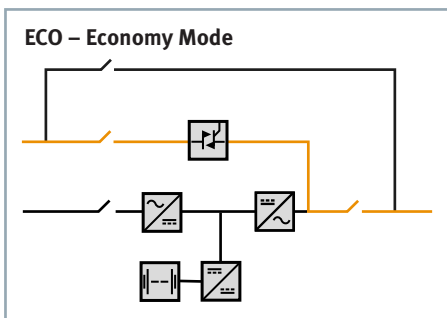

- UPS is running in static bypass state
- Efficiency up to 99%
- Mains battery switching time is about 10 ms

PowerTower Green CMS Features

OPTIMISE CAPITAL INVESTMENT

The BPC PowerTower can be scaled in vertical modular steps up to 1200kVA of power in a single frame, providing a cost effective method of building any data centre without oversizing that can result in energy waste. Flexibility and cost effective 'right sizing' of any UPS system must be priority when increasing or decreasing power to meet future requirements.

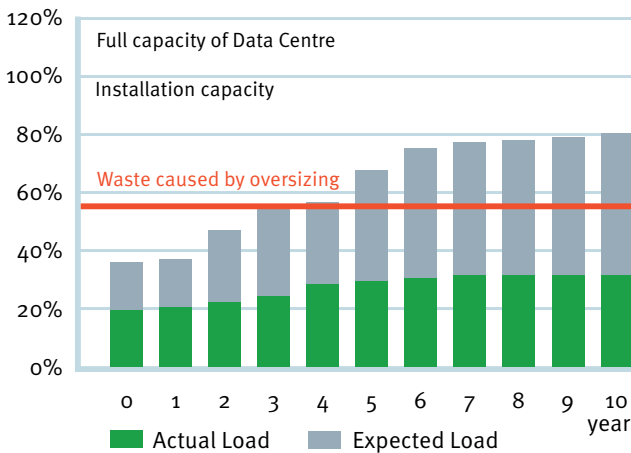

Oversizing Results in Energy Waste

EXCELLENT POWER PERFORMANCE

The PowerTower UPS has a near unity input power factor at full load, reducing the size of the input cables/fuses. Low total input harmonic distortion (THDi <3%) reduces load pollution, increases power quality and optimises generator sizing. Overall this excellent power performance directly translates into significant reduction in installation costs and extends the life of valuable equipment.

DYNAMIC AIR FLOW AND DUST FILTERS

The PowerTower Green dynamic air flow technology takes cool air from the front of each module. Simply directing the heat dissipated from the active power electronics and exhausting the higher core temperature out the rear.

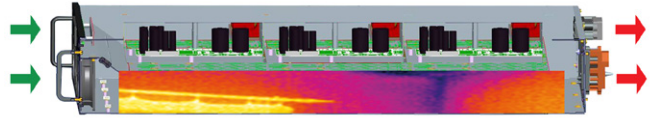

Incorporating dust filters into each cabinet for optimum cooler and cleaner design resulting in longer component design life and increasing periods between maintenance visits. Available as standard on 25kVA, 50kVA & 75kVA modular cabinets.

SMALL FOOTPRINT

The PowerTower Green can deliver one of the smallest surface areas; less than 500kW/m² and requires minimal clearance around the unit so floor space required in data centres for UPS can be kept to an absolute minimum.

TRUE 'HOT SWAP' CAPABILITY

The BPC PowerTower modular UPS operates a true hot swap technology where each power module is automatically synchronised to the load sharing of the system. There is no need to identify individual power modules or sequence them in any particular order. The monitoring module is also designed to be hot swappable, making system maintenance easy. Simply insert the power and monitor modules into the slots and engage. The process of replacement or vertical scalability is easily achieved, and hot swapping means no downtime and the service/ operating personnel do not require special skills.



Easy hot swappable design modules

EASY INSTALLATION & OPERATION

The PowerTower offers a flexible install so assembly time is greatly reduced. Bottom and top entry with generous cable management will simplify the more difficult installation. BPC's PowerTower Green UPS is very easy to maintain and control, providing the highest reliability and best protection for supplying power.

Options are available for Galvanic Isolation Transformer cabinet, improved battery management, frequency conversion, conformal coating, input & output switchgear.

LOW MTTR AND 99.9999% AVAILABILITY

The 'hot swap' modularity design of the PowerTower Green provides a high mean time between failure (MTBF), allowing the user to replace and add modules without the risk of downtime, ultimately reducing mean time to repair (MTTR). Whereas a standalone unit takes typically 6 hours to repair, the PowerTower modular UPS can be reduced to less than 30 minutes, giving 'six nines' power availability.

HIGH LOAD ADAPTABILITY (BLADE FRIENDLY)

All PowerTower Green Modular UPS systems are provided with an output power factor of 0.9 & 1.0, providing fully rated output active power without de-rating in the range of 0.7 lagging to 0.8 loading in compliance with modern IT equipment.

SINGLE FRAME CONCEPTS

BPC offers more single frame solutions than any other manufacturer, with 12, 24, 36, 30, 60, 120, 150, 200, 250, 300, 400, 450, 500, 600, 900 & 1200kVA chassis, reducing the need to parallel cabinets and improving the reliability of installations. All systems can be configured to various input and output configurations 1/1, 3/1, 1/3 and 3/3 phases.

FLEXIBLE MODULAR AND SCALABLE DESIGN

With the ever increasing demands of power, the PowerTower Green UPS allows you to increase your power capacity in small steps reducing initial costs and over sizing. This flexibility can extend both vertically and horizontally so as your business grows, the PowerTower Green UPS grows with you.

HIGH EFFICIENCY

The PowerTower Green offers true online efficiency over 96.5% even at 30% load, significantly reducing system running costs and site air conditioning expenses, thus helping to reduce the organisations carbon footprint.

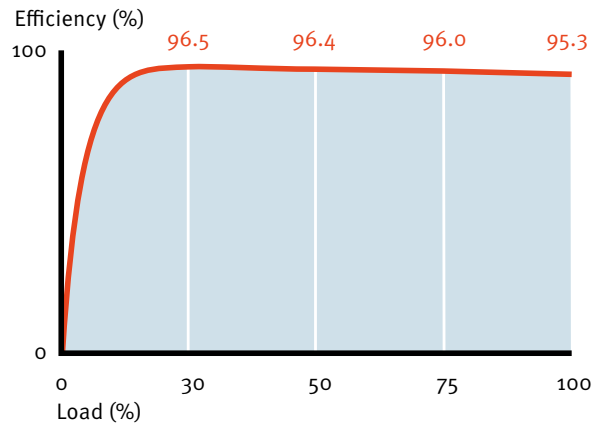

Taking a small to medium data centre 200kVA/180kW load and air conditioned with coefficient performance of 3:1

- Save 127,144KWh per year compared to traditional UPS (90% efficiency)
- Save 210,240KWh per year compared to legacy UPS (86% efficiency)

In DC/AC inverter mode, when the power supply is not present, the battery efficiency is over 95% reducing actual battery capacity requirement and improving design life.

TOTAL COST OF OWNERSHIP (TCO)

The PowerTower Green UPS offers today's data centre management the opportunity for sustainability and future growth. With flexibility and scalability combined with lower cost of service contracts, short and long term, it can increase savings on overall operations.

Vertical Scalability
by adding power modules up to 1200kVA



Horizontal Scalability

possible with up to 4 frames in parallel, achieving total power capacity of 4.8MVA

PowerTower™ Green RITo6 Series

Rack Independent Online Double Conversion UPS

6kVA – 36kVA



The PowerTower Green RITo6 series is a rack independent modular UPS of low and medium power developed by BPC. With a flexible structure, it can be embedded into any standard 19 inch cabinet and can be configured to operate in any power requirement.

Ranging from 6-36kVA using 6kVA modules in a functional rack independent solution, the PowerTower Green RITo6 series is ideal for the space conscious enterprise networking manager.

PTG RIT 12/6

12kVA – 2 module rack 19" (w) x 600mm (d) x 3U (h)



PTG RIT 24/6

24kVA – 4 module rack 19" (w) x 600mm (d) x 5U (h)



PTG RIT 36/6

36kVA – 6 module rack 19" (w) x 600mm (d) x 7U (h)



- N+X module-level redundancy UPS System
- 1/1, 3/1, 1/3 and 3/3 configuration via display
- Multi-level decentralized control technology and Master-slave synchronization in sequence control eliminating system failure bottleneck
- Each module equally shares the input and output current automatically, and all UPS modules share the batteries
- Battery discharge management, auto-transfer between floating and equal charging, temperature compensation
- Multiple User options RS232, RS485, dry contacts, TCP/IP Adapter for local and remote communication
- Optional input/output transformer

RIT Monitoring Module

Display, Monitoring, Communication and Alarm Management



PTG6M Power Module

Rectifier, Inverter, Battery Charger, Control



PowerTower Green RITo6 Technical Specification

MODEL	PTGRIT 12/6	PTGRIT 24/6	PTGRIT 36/6
Maximum Power kVA	12kVA	24kVA	36kVA
Compatible Power Module	PTG6M		
INPUT			
Nominal Voltage	(1PH + N + E) 380V/220V ±25%		(1PH + N + E) or (3PH + N + E) 380V/220V ±25%, 400V/230V ±25%, 415V/240V ±25%
Frequency Range	50Hz ±10%, 60Hz ±10%		
Power Factor	≥0.99		
OUTPUT			
Nominal Voltage	(1PH + N + E) 220, 230, 240Vac		(1PH + N + E) or (3PH + N + E) 380/220Vac 400/230Vac 415/240Vac
AC Voltage Regulation	±1%		
Power Factor	0.9		
Crest Factor	3:1		
Harmonic Distortion (Linear Load)	≤1%		
Transfer Time	Zero		
EFFICIENCY			
ONLINE Mode	≥95%		
Battery Mode	≥98%		
BATTERY			
Rated DC Input Voltage	±240Vdc		
Charging Ability	Within 10 hours (2 hours backup)		
GENERAL			
Display	LCD/LED Screen		
Communication	RS232, RS485, 2 dry contact, TCP/IP adaptor		
Ambient Temperature	-25°C ~ 60°C		
Operating Temperature	-5°C ~ 40°C		
Operating Humidity	≤95% (non-condensed)		
Dimensions (mm) WxDxH	480 x 600 x 133 (3U)	480 x 600 x 222 (5U)	480 x 600 x 311 (7U)
Net Weight (kgs)	12	16	20
MODEL - POWER MODULE	PTG6M		
Capacity kVA/kW	6/5.4		
Input/Output Mode	1/1, 3/1, 1/3, 3/3 (Ph + N + E)		
Input PF	≥0.99		
THDI	≥3%		
Overload Ability	125% for 10 min, 150% for 1 min		
Max. Charging Power	3 A		
Max. Heat Dissipation	338W		
Dimensions (mm) WxDxH	219 x 487 x 83		
Net Weight (kgs)	7.5		

PowerTower™ Green CMS Series

Online Double Conversion Modular UPS

10kVA – 1200kVA



» Modular Design » Scalable » Pay as you grow



BPC Energy have introduced new 15kVA, 25kVA, 50kVA and 75kVA modules to provide even better vertical and horizontal scalability offering end users and data centre management power protection capacity from 15kVA up to 1200kVA in single newly-developed dedicated cabinets and parallel options up to 4.8MVA.

BPC Energy have the widest choice of selected capacity modular options in the UPS industry and design specifically for data centres, computer systems and critical applications.

PowerTower Green CMS Range is capable of achieving exceptional efficiency of >96.5% in online double conversion mode. Also includes advanced technology that boosts efficiency to above 96% at lower loads such as only 30% to 50% without effecting the online protection.

Where sites have stable mains supply and, at times, the critical loads are inactive, it would be possible to

consider the ECO economy mode where efficiency of 99% can be achieved. However, note that there is a fractional break in power while the UPS switches back to the inverter.

Unique to the PowerTower Green PTG25UM/PTG50UM & PTG75UM modules are the new “SMART Energy” option which is the introduction of the “Ultra Saving Line Mode” which can achieve efficiency up to 98.8% still meeting the IEC62040 power supply quality to the load. In addition to the backup function the modules can be used to save operating costs during peak loading.

- » **Financial Data Centre**
- » **Internet Data Centre**
- » **Disaster Recovery Data Centre**
- » **Telecom Central Systems**
- » **Government Authorities**

PowerTower Green CMS Features

STS MODULE

- Transfer time < 1ms
- Overload ability
- Self-diagnostics, interlock and protection functions

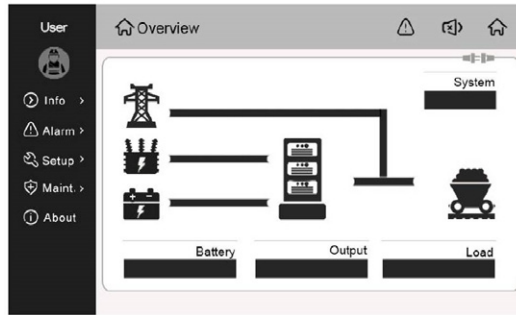

MONITOR MODULE

- Dual core 16-bit processor
- Easy to read 240 x 64 LCD touch controller
- Display of general, system, battery and module information, system output, event record and index set up
- RSS232 and RS485 communication
- Output dry contacts
- TCP/IP, SNMP (optional)

POWER MODULES

PTG15UM – 15kVA/15kW Power Module



PTG25UM – 25kVA/25kW Power Module



PTG50UM – 50kVA/50kW Power Module

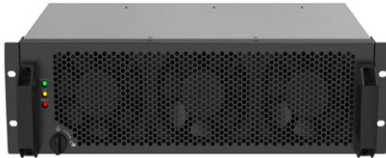

PTG75UM – 75kVA /75kW Power Module



CABINET OPTIONS

Additional space for cable management



Input and output switch breakers can be included

- Online double conversion technology ensures reliable power supply
- High efficiency reduces power and cooling costs
- Each UPS module is a fully functional UPS including a converter, inverter, charger and controller
- Intelligent communication ports
- Dust filter module design for the 25kVA / 50kVA / 75kVA options

*Image may differ from product

PowerTower™ Green CMS15 Range

Three Phase Online Double Conversion UPS

15kVA – 120kVA



PTGCMS 30/15U

- Max capacity of system: 30kVA
- Power module model: PTG15UM
- Power module capacity: 15kVA
- 2 module slots

The CMS 15 Range also has a flexible rack independent structure which can be fitted into any 1000mm deep 19" cabinet or specialised high IP enclosure.



PTGCMS 60/15U

- Max capacity of system: 60kVA
- Power module model: PTG15UM
- Power module capacity: 15kVA
- 4 module slots



PTGCMS 120/15U

- Max capacity of system: 120kVA
- Power module model: PTG15UM
- Power module capacity: 15kVA
- 8 module slots

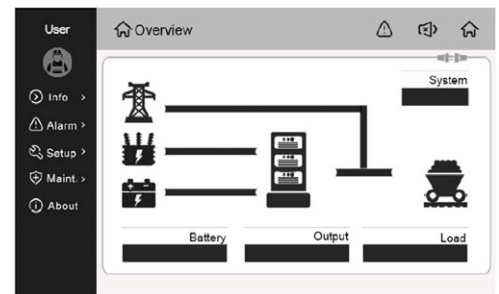

Colour 7 inch touch screen LCD display panel providing all UPS control parameters, status and alarm information.

**Image may differ from product*

PowerTower Green CMS15 Technical Specification

MODEL - CABINET		PTGCMS 30/15U	PTGCMS 60/15U	PTGCMS 120/15U
Power Rating kVA/KW		30	60	120
Compatible Power Module		PTG15UM		
INPUT				
Nominal Voltage		380V / 220V, 400V / 230V, 415V / 240V (1Ph + N + E, 3Ph + N + E)		
Voltage Range		176 - 276 @ full load : 132 - 276 @ half load		
Frequency Range		50 Hz or 60 Hz		
Power Factor		≥0.99		
OUTPUT				
Nominal Voltage		380 Vac / 220 Vac, 400 Vac / 230 Vac, 415 Vac / 240 Vac (1Ph + N + E, 3Ph + N + E)		
AC Voltage Regulation (Battery Mode)		±1%		
Power Factor		1.0 Unity		
Crest Factor		3:1		
Harmonic Distortion (Linear Load)		THD <3%		
Transfer Time		Zero		
Waveform		Sinewave		
EFFICIENCY				
ONLINE Mode		≥96%		
ECO Mode		≥99%		
Battery Mode		≥98%		
BATTERY				
Battery Type		VRLA Sealed Lead Acid/ Gel/ Lithium/ Nickel Cadmium Maintenance Free Batteries		
Rated DC Voltage		Nominal ±240Vdc (rated 40 blocks x 12Vdc: settable from 32 - 44 blocks)		
Charging Ability		10 hours (2 hours back up)		
Charging Voltage Stability		±1%		
GENERAL				
Display		Touch LCD/LED Screen		
Communication		RS232, RS485, 8 dry contacts, TCP/IP adaptor, SNMP (optional)		
Operating Temperature		0 - 40°C		
Operating Humidity		0 - 90% (non-condensed)		
Acoustic Noise		70 dB @ 1 metre		
Protection Degree		IP20		
Cabinet (single)	Dimensions (mm) WxDxH	442 x 800 x 662	442 x 800 x 840	442 x 800 x 1195
	Weight (kgs)	82	92	118
MODEL - POWER MODULE		PTG15UM		
Capacity kVA/kW		15kVA/15kW		
Input/Output Mode		1/1, 3/1, 1/3, 3/3 (Ph + N + E)		
Input Power Factor		≥0.99		
THDI		≥3%		
Overload Ability		110% for 60 mins, 125% for 10 mins, 150% for 1 sec		
Max. Charging Power		3A		
Max. Heat Dissipation		590W		
Dimensions (mm) WxDxH		380 x 590 x 88		
Net Weight (kgs)		16		

PowerTower™ Green CMS25 Range

Three Phase Online Double Conversion UPS

25kVA – 250kVA



PTGCMS 150/25U

- Max capacity of system: 150kVA
- Power module model: PTG25UM
- Power module capacity: 25kVA
- 6 module slots



PTGCMS 250/25U

- Max capacity of system: 250kVA
- Power module model: PTG25UM
- Power module capacity: 25kVA
- 10 module slots

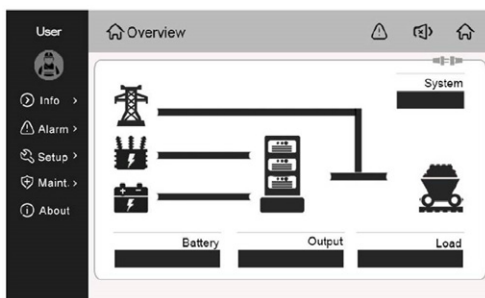

Colour 7 inch touch screen LCD display panel providing all UPS control parameters, status and alarm information

**Image may differ from product*

PowerTower Green CMS25 Technical Specification

MODEL - CABINET		PTGCMS 150/25U	PTGCMS 250/25U
Power Rating kVA/KW		150/150	250/250
Compatible Power Module		PTG25UM	
INPUT			
Nominal Voltage		380 V / 220 V, 400 V / 230 V, 415 V / 240 V (1Ph + N + E, 3Ph + N + E)	
Voltage Range		176 - 276 @ full load : 132 - 276 @ half load	
Frequency Range		50 Hz or 60 Hz	
Power Factor		≥0.99	
OUTPUT			
Nominal Voltage		380 Vac / 220 Vac, 400 Vac / 230 Vac, 415 Vac / 240 Vac (1Ph + N + E, 3Ph + N + E)	
AC Voltage Regulation (Battery Mode)		±1%	
Power Factor		1.0 Unity	
Crest Factor		3:1	
Harmonic Distortion (Linear Load)		THD ≤3%	
Transfer Time		Zero	
Waveform		Sinewave	
EFFICIENCY			
ONLINE Mode		≥96%	
ECO Mode		99%	
Battery Mode		≥95%	
BATTERY			
Battery Type		VRLA Sealed Lead Acid / Gel / Lithium / Nickel Cadmium Maintenance Free Batteries	
Rated DC Input Voltage		Nominal ±240Vdc (rated 40 blocks x 12Vdc: settable from 32 - 44 blocks)	
Charging Ability		10 hours (2 hours back up)	
Charging Voltage Stability		±1%	
GENERAL			
Display		Touch LCD/LED Screen	
Communication		RS232, RS485, 8 Dry Contacts, TCP/IP Adaptor, SNMP (Optional)	
Operating Temperature		0 - 40°C	
Operating Humidity		0 - 90% (non-condensed)	
Acoustic Noise		70 dB @ 1 metre	
Protection Degree		IP20	
Cabinet (single)	Dimensions (mm) WxDxH	600 x 1000 x 1600	600 x 1000 x 2000
	Net Weight (kgs)	210	260
MODEL - POWER MODULE		PTG25UM	
Capacity kVA/kW		25/25	
Input / Output Mode		1/1, 3/1, 1/3, 3/3, (Ph + N + E)	
Input Power Factor		±0.99	
THDI		≥3%	
Overload Ability		110% for 60 mins, 125% for 10 mins, 150% for 1 sec	
Max. Charging Power		5A	
Max. Heat Dissipation		900W	
Dimensions (mm) WxDxH		442 x 590 x 88	
Weight (kgs)		19	

PowerTower™ Green CMS50 Range

Three Phase Online Double Conversion UPS

200kVA – 500kVA



PTGCMS 200/50U

- Max capacity of system: 200kVA
- Power module model: PTG50UM
- Power module capacity: 50kVA
- 4 module slots



PTGCMS 300/50U

- Max capacity of system: 300kVA
- Power module model: PTG50UM
- Power module capacity: 50kVA
- 6 module slots



PTGCMS 400/50U

- Max capacity of system: 400kVA
- Power module model: PTG50UM
- Power module capacity: 50kVA
- 8 module slots



PTGCMS 500/50U

- Max capacity of system: 500kVA
- Power module model: PTG50UM
- Power module capacity: 50kVA
- 10 module slots

**Image may differ from product*

PowerTower Green CMS50 Technical Specification

MODEL - CABINET		PTGCMS 200/50U	PTGCMS 300/50U	PTGCMS 400/50U	PTGCMS 500/50U
Power Rating kVA/KW		200	300	400	500
Compatible Power Module		PTG50UM			
INPUT					
Nominal Voltage		380V/220VAC, 400V/230VAC, 415V/240VAC			
Voltage Range		132-276 VAC, (If 132-176VAC, 50% load max.)			
Frequency Range		40-70Hz			
Power Factor		≥0.99			
OUTPUT					
Nominal Voltage		380V/220VAC, 400V/230VAC, 415V/240VAC			
AC Voltage Regulation (Battery Mode)		±1%			
Power Factor		1.0 Unity			
Crest Factor		3:1			
Harmonic Distortion (Linear Load)		≤2%			
Transfer Time		Zero			
Waveform		Sinewave			
EFFICIENCY					
ONLINE Mode		96.5%			
ECO Mode		99%			
Battery Mode		≥95%			
BATTERY					
Battery Type		VRLA Sealed Lead Acid / Gel / Lithium / Nickel Cadmium Maintenance Free Batteries			
Rated DC Input Voltage		Nominal ±240Vdc (rated 40 blocks x 12Vdc: settable from 32 - 44 blocks)			
Charging Ability		10 hours (2 hours back up)			
Charging Voltage Stability		±1%			
GENERAL					
Display		Touch LCD/LED Screen			
Communication		RS232, RS485, 8 Dry Contacts, TCP/IP Adaptor, SNMP (Optional)			
Operating Temperature		-5°C - 40°C			
Operating Humidity		≤95%, (non-condensed)			
Acoustic Noise		≤70 dB @ 1 metre			
Protection Degree		IP20			
Cabinet (single)	Dimensions (mm) WxDxH	600 x 1000 x 1600	900 x 1000 x 1200	900 x 1000 x 2000	1200 x 1000 x 2000
	Net Weight (kgs)	220	300	340	380
MODEL - POWER MODULE		PTG50UM			
Capacity kVA/kW		50/50			
Input / Output Mode		1/1, 3/1, 1/3, 3/3, (Ph + N + E)			
Input Power Factor		≤0.99			
THDI		≤3%			
Overload Ability		110% for 60 mins, 125% for 10 mins, 150% for 1 sec			
Max. Charging Power		6kW			
Max. Heat Dissipation		1500W			
Dimensions (mm) WxDxH		482 x 622 x 129			
Weight (kgs)		30			

PowerTower™ Green CMS75 Range

Three Phase Online Double Conversion UPS

75kVA – 1200kVA



PTGCMS 450/75U

- Max capacity of system: 450kVA
- Power module model: PTG75UM
- Power module capacity: 75kVA
- 6 module slots

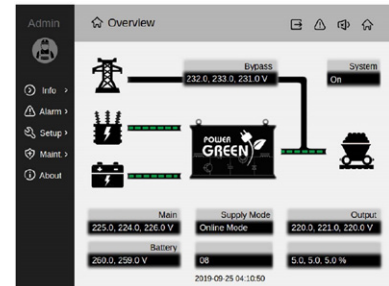

Colour 10 inch touch screen LCD display panel providing all UPS control parameters, status and alarm information

PTGCMS 600/75U

- Max capacity of system: 600kVA
- Power module model: PTG75UM
- Power module capacity: 75kVA
- 8 module slots



PTGCMS 900/75U and 1200/75U

- Max capacity of system: 900kVA and 1200kVA
- Power module model: PTG75UM
- Power module capacity: 75kVA
- 12 and 16 module slots

**Image may differ from product*

PowerTower Green CMS75 Technical Specification

MODEL - CABINET	PTGCMS 450/75U	PTGCMS 600/75U	PTGCMS 900/75U	PTGCMS 1200/75U	
Power Rating kVA/KW	450/450	600/600	900/900	1200/1200	
Compatible Power Module	PTG75UM				
INPUT					
Nominal Voltage	380 V / 220 V, 400 V / 230 V, 415 V / 240 V (1Ph + N + E, 3Ph + N + E)				
Voltage Range	176 - 276 @ full load : 132 - 276 @ half load				
Frequency Range	50 Hz or 60 Hz				
Power Factor	≥0.99				
OUTPUT					
Nominal Voltage	380 Vac / 220 Vac, 400 Vac / 230 Vac, 415 Vac / 240 Vac (1Ph + N + E, 3Ph + N + E)				
AC Voltage Regulation (Battery Mode)	±1%				
Power Factor	1.0 Unity				
Crest Factor	3:1				
Harmonic Distortion (Linear Load)	THD ≤3%				
Transfer Time	Zero				
Waveform	Sinewave				
EFFICIENCY					
ONLINE Mode	≥96.5%				
ECO Mode	≥99%				
SMART Energy Mode	≥98.5%				
Battery Mode	≥95%				
BATTERY					
Battery Type	VRLA Sealed Lead Acid / Gel / Lithium / Nickel Cadmium Maintenance Free Batteries				
Rated DC Input Voltage	Nominal ±240Vdc (rated 40 blocks x 12Vdc: settable from 32 - 44 blocks)				
Charging Ability	10 hours (2 hours back up)				
Charging Voltage Stability	±1%				
GENERAL					
Display	Touch LCD/LED Screen				
Communication	RS232, RS485, 8 Dry Contacts, TCP/IP Adaptor, SNMP (Optional)				
Operating Temperature	0 ~ 40°C				
Operating Humidity	0-90% (non-condensed)				
Acoustic Noise	70dB @ 1 metre				
Protection Degree	IP20				
Cabinet (single)	Dimensions (mm) WxDxH	900 x 1000 x 2000	1200 x 1000 x 2000	1800 x 1000 x 2000	2000 x 1000 x 2200
	Net Weight (kgs)	364	413	658	700
MODEL - POWER MODULE		PTG75UM			
Capacity kVA/kW	75/75				
Input / Output Mode	1/1, 3/1, 1/3, 3/3, (Ph + N + E)				
Input Power Factor	±0.99				
THDI	≥3%				
Overload Ability	110% for 60 mins, 125% for 10 mins, 150% for 1 sec				
Max. Charging Power	15A				
Max. Heat Dissipation	2900W				
Dimensions (mm) WxDxH	482 x 628 x 176				
Weight (kgs)	45				

Accessories

Extensive range of accessories to accompany the PowerTower Modular Range

EXTERNAL MAINTENANCE BYPASS

BPC UPS are equipped with an Internal Static Switch allowing for instantaneous transfer to mains supply when the power demand of the load exceeds the overload level of the inverter or a short circuit is experienced.

However, an optional External Manual Bypass Switch facility may be provided to offer the opportunity to do commissioning, routine maintenance, repair or removal of the equipment without any interruption to the critical load. Both make-before-break (MBB) and break-before make (BBM) bypass switch designs are available.

A comprehensive range of bypass switches which are built to the highest standard using proven components are available in both single and three phase, with variations for dual input supplies or parallel redundant configurations.



SWITCHABLE & CHANGEOVER PANELS

Every switchboard is individually designed to suit our clients requirements including:

- Forms of separation: Form 2 to 4, type 1 to 7
- Ratings: 100A to 6300A
- Type tested assemblies (IEC 61439-1)
- Board access: Front and rear
- Mains, gen-man, auto changeover controls
- Electrical or mechanical interlocking
- Restricted or unrestricted earth fault
- Power factor correction (switchboard or stand alone)
- Surge protection



BATTERY OPTIONS

BPC offer a comprehensive range of battery options which include open steel battery stands and cladded enclosed battery racks that can easily be assembled and disassembled, also including complete battery cabinet system options.

Various battery types are compatible with the PowerTower Green Range, including VRLA maintenance free, Nickel Cadmium, Lithium-Ion and GEL to provide a solution for all applications and design life requirements.

BPC also offer battery testing accessories for voltage and impedance testing along with insulated battery tools to simplify safe battery maintenance.



BATTERY CHARGER MODULE OPTIONS



* Product may differ from image

All BPC PowerTower Green power modules have adequate battery chargers internally for normal end-user and data centre protection.

ADDITIONAL CHARGER POWER

For extreme environmental applications requiring long autonomy backup runtimes or faster than recharge times, BPC can offer additional battery charger modules which each have 50 Amps maximum charger power and can be paralleled for even greater recharge power. Correct charging characteristics can prevent continuous under-charge from the rectifier which can result in permanent loss of battery capacity or even premature battery failure.

ADAPTED CABINET DESIGN

BPC PowerTower Green cabinets can be adapted, at the time of order, to include a selection of power modules and battery charger modules so that the internal space design can be tailor-made to the requirements of the client.

Networking Intelligent Power Management

SIMPLE NETWORKING MANAGEMENT PROTOCOL (SNMP) CARDS AND ADAPTORS

SNMP cards are used for the management of UPS systems via a computer or local network. With a web based programme built into the SNMP, simply connecting the card to a network via its LAN port allows for easy monitoring of the UPS. SNMP cards can be used not only to monitor UPS parameters, but also allow user controlled testing, email alerts and sending of remote console commands to client systems to initiate automatic shutdowns. SNMP cards can be fitted internally on some UPS models or externally fitted via the UPS RS232 port.



MODBUS ADAPTORS

BPC have a wide range of MODBUS/BUS adaptors that support RS485 and TCP/IP connectivity to ensure the device provides continuous, reliable and accurate network monitoring of the UPS system through a Building Management System (BMS).

GSM MODEM

When connected to advanced SNMP cards the GSM MODEM can send SMS alerts via a telephone sim card.

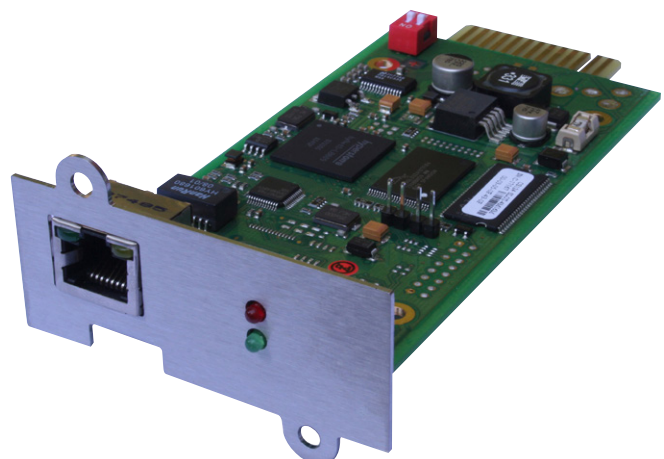

After Sales Support

INSTALLATION & COMMISSIONING

All BPC installations are carried out by approved engineers who are experts in the installation of UPS and related equipment. If required, BPC can provide a managed turnkey service which provides for delivery to site and all associated installation electrical and building work. All BPC installations are compliant with current regulations and full certification will be issued on completion.

BPC are able to meet with all your exact requirements regardless of the size or complexity of your application. A solution can be tailored to suit both your commercial and technical requirements by utilising either modified commercially off the shelf (COTS) products or custom built as a bespoke product.

BPC have a dedicated team of managers and engineers who can provide a total solution from surveying your site through to complete commissioning of the system. It is vital that your UPS or Static Inverter is fully commissioned to ensure it is installed and running correctly. Commissioning by a trained engineer will check the performance of the system whilst also checking the environment is suitable to achieve maximum service life.



MAINTENANCE & SERVICE PLANS

Any power protection equipment is an investment for any sized company and having the reassurance that your equipment is maintained to ensure full life expectancy is key.

BPC can offer a range of maintenance agreements all with 24 hour telephone support. Agreements vary in price depending on the level of support and response time required. Options from next working day to 4 clock hour responses are available nationwide. BPC can be very flexible to suit customer requirements whether it is an additional annual visit or strategic spare part requirements.

With the knowledge and experience to support third party equipment it is now even easier to choose BPC as your service provider, allowing us to support all your equipment at site regardless of quantity, size, make or model, ensuring a high level of support and one single point of contact.

HAZARDOUS WASTE DISPOSAL

Due to tight regulations within England and Wales on the transport of batteries that are at the end of their life, BPC Energy are fully equipped to offer complete removal and replacement services. BPC are registered upper tier waste carriers for the safe transportation of batteries with the Environment Agency in England & Wales. Registration No. CB2U66604.

The BPC Group

BPC is an international company operating for 25 years globally, with partners and distributors located around the world.

These regions include:

EUROPE

UK, France, Germany, Gibraltar, Ireland, Netherlands, Malta, Norway, Portugal, Russia.

MIDDLE EAST

Bahrain, Georgia, Iraq, Jordan, Kuwait, KSA, Lebanon, Oman, Qatar, Syria, Turkey, UAE, Yemen.

AFRICA

Algeria, Botswana, Burkina Faso, Democratic Republic of the Congo, Egypt, Ethiopia, Ghana, Kenya, Libya, Mozambique, Nigeria, Rwanda, Sierra Leone, South Africa, Sudan, Tanzania, Uganda, Zambia.

FAR EAST & ASIA

India, Pakistan, Sri Lanka, Indonesia.

To ensure a high level of pre and post sales support is offered, BPC work closely with distributors, providing key commercial and technical training whilst providing competitive costing structures tailored to specific region markets, ensuring the most suitable BPC products are offered. We pride ourselves on long standing relationships with our partners which is reflected in the ongoing support provided locally.

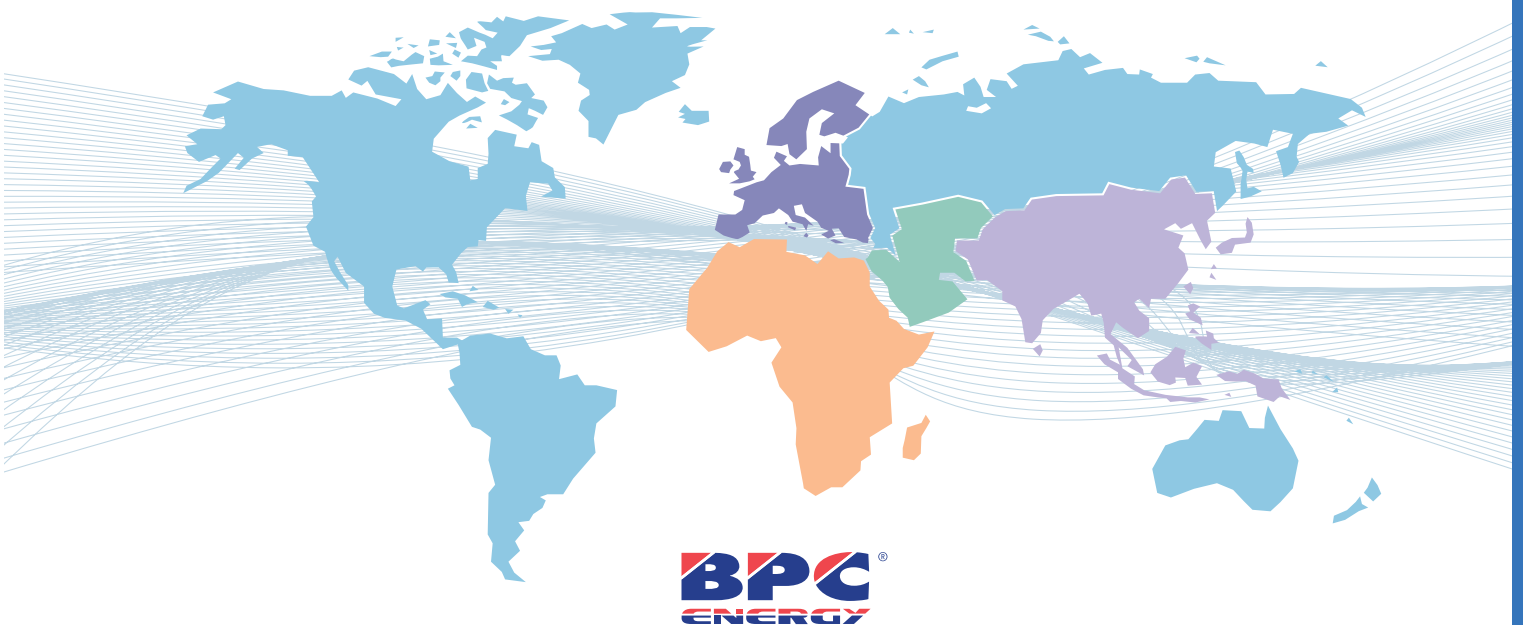

The British Power Conversion Company

Authorised Distributor



BPC Energy Limited

BPC House
Romsey Industrial Estate
Greatbridge Road
Romsey
Hampshire SO51 0HR
United Kingdom

Tel: +44 (0) 1794 521200
Fax: +44 (0) 1794 521400
e-mail: sales@bpc-ups.com



*All product specifications are subject to change without notice. Final product may differ from images included in this catalogue.
All trademarks mentioned are the properties of their respective owners.*

BPCM0402 – Issue 1